

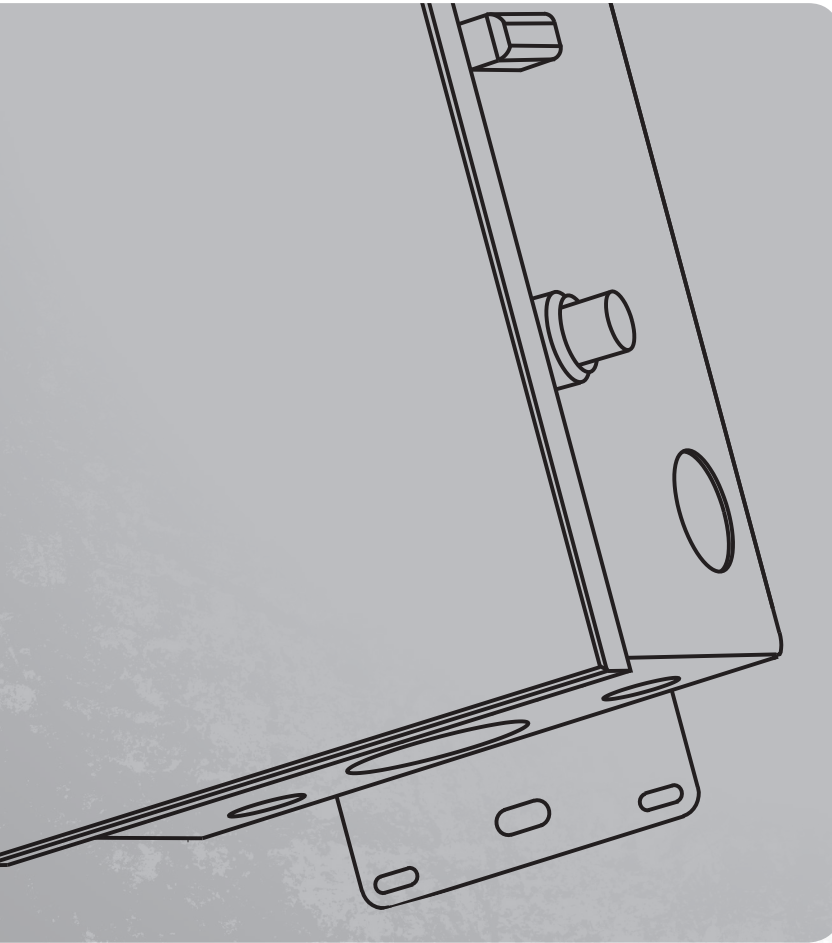

POTENZA X TRANSFORMER

Professional Series Installation Instructions



ETL Listed to UL Standards For Safety:

ETL 1838 LANDSCAPE
ETL 379 POOL & SPA



TABLE OF CONTENTS

About The PX Series Transformer	1
Installing The PX Series Transformer	2
Circuiting Guidelines	5
General Notes	7
Switching Options	8
LiteSpice Installation	10
Installation Tools	11
System Diagnosis And Troubleshooting	13
System Maintenance	16
Glossary	17
Warranty	17
Questions?	18

ABOUT THE PX SERIES TRANSFORMER

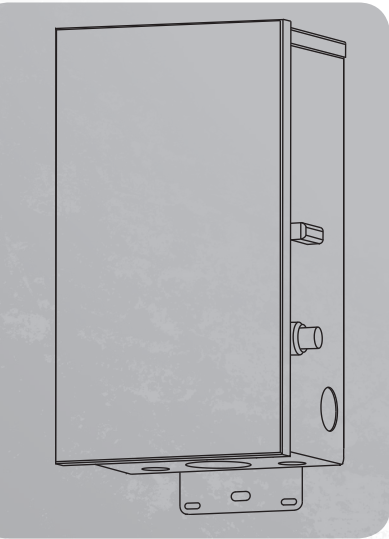

Congratulations on your purchase of the FX Luminaire PX Series Transformer!

This installation guide is designed to walk you through the proper methods of installing your new lighting system. The PX Series Transformer is the “heart” of your system. Its function is to provide a safe and consistent flow of proper electrical power to each of the fixtures installed in the garden. All PX Transformers are ETL Listed for UL Standards for Safety ETL 1838 Landscape and ETL 379 Pool and Spa Ratings.

The PX Series Transformer is a magnetic core-coil, multi-tap unit made from 304 stainless steel. The multi-tap configuration provides lugs with voltage outputs of 11, 12, 13, or 14 volts on the PX-300 and PX-600 models and 12, 13, and 14 volts on the PX-900 model. The multi-tap feature allows the installer to compensate for voltage drop, thereby balancing the system for long lasting, efficient performance.

An important consideration when designing a lighting system is how it will be actuated. The PX Transformer offers open switching control architecture, which will accommodate many switching modes.

Your PX Transformer includes an accessories bag, which is filled with what you'll need to properly install the transformer. The bag consists of a mounting template, mounting screws, a red jumper wire and the bootie. You may need to purchase plastic anchors if mounting the PX Transformer on a stucco or masonry wall.

INSTALLING THE PX SERIES TRANSFORMER

STEP 1 - LOCATING THE TRANSFORMER

Locate transformer(s) in a well ventilated area away from direct irrigation spray and central to where the majority of the lighting fixtures will be installed. The goal is to minimize the length of cable runs from your transformer to the lighting fixtures thus minimizing voltage drop and cable size.

Transformer(s) with power cords must be located adjacent to a 120 volt GFCI protected exterior electrical receptacle. If a 120 volt power source is not available at the desired transformer installation location, it is advised that you hire a licensed electrician to run a dedicated 120 volt, 15 amp circuit to the desired location.

Test all existing receptacles with both a receptacle tester and a digital voltmeter or amp clamp to verify proper wiring and voltage at the receptacle.

SINGLE TRANSFORMER

When using only one transformer, it is very important to center the transformer on the wattage load. If the project calls for 135 watts in both front and back yard, the PX-300 or PX-600 should be centered on the side of the house that will receive the most lighting. A common mistake is to locate the single transformer on the service side of the house or in the garage, which might result in excessively long cable runs to reach lighted areas. The primary goal in laying out low voltage systems is to minimize cable runs because of the negative effect voltage drop has on lamp output performance.

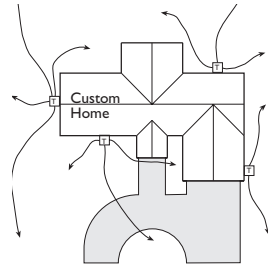

Sample diagram of home with transformer and lamp placement

MULTIPLE TRANSFORMERS

A common mistake in laying out multiple transformer circuits is to group several transformers in one location because of utility or visual considerations only. As with any low voltage layout, the prime directive should be to locate the transformers as close to the fixtures as possible in order to minimize cable runs and resulting voltage drop. The other multi-transformer layout consideration is "use zoning." Having several transformers allows the client to selectively control light in separate areas. This approach is similar to irrigation design in that the goal is to individually control areas that have similar needs. In lighting, a recreation area has different lighting needs than front entry. Therefore, the lights that serve these different lighting use areas need to be on separate transformers and switch controls.

INSTALLING THE PX SERIES TRANSFORMER

STEP 2 – MOUNTING TRANSFORMERS

Wall Mount – By code, all transformers must be installed a minimum of 12" above finish grade as measured from finish grade to the bottom of the transformer. Using the template enclosed within the accessories bag and a 9" torpedo level, mark top anchor locations on wall, drill pilot holes, insert anchors and install screws into anchors leaving approximately 1/8" of thread exposed on the screw. Mount transformer on screws.

Mark locations for bottom anchors with permanent marker. Remove transformer from wall. Drill bottom anchor holes, install anchors. Place transformer back on top anchors and install screw(s) into anchors at bottom of transformer to secure it to the wall.

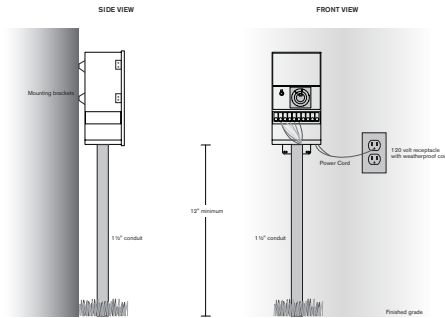

Post Mount Installation – Install pressure treated 4" x 4" x 36" (min) post in concrete footing. Install single anchor screw (provided) 1 1/2"–2" below the top of post. Place transformer on screw. Place 9" torpedo level on top of transformer and level transformer. Once level, secure transformer to post by installing 1 or 2 screws on the bottom mounting bracket.

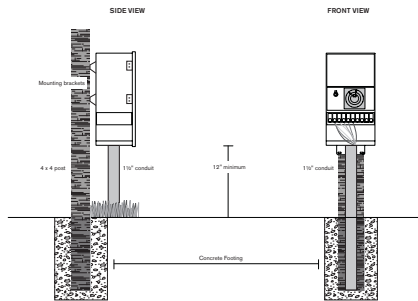

For additional information regarding installation techniques, visit www.fxl.com and click on Learning Center.

Transformer Electrical Notes	Max Wattage Load	Max Low Volt Amps	Max Hi Volt Amps
PX-300 Series Transformers	300 watts	25 amps	2.5 amps
PX-600 Series Transformers	600 watts	50 amps	5.0 amps
PX-900 Series Transformers	900 watts	75 amps	7.5 amps

All PX Series Transformers come equipped with a 3 foot, 12 gauge, 3-prong electrical power cord to be used in conjunction with a typical 120 volt electrical receptacle. The PX power cord should be used only in conjunction with a GFCI protected 120 volt exterior receptacle.

For hard wire installations, remove the PX power cord and wire the transformer in compliance with local electrical building codes. It is recommended that the electrician install a dedicated 15 or 20 amp circuit breaker in the electrical panel.

INSTALLING THE PX SERIES TRANSFORMER

STEP 3 - RUNNING CABLE TO FIXTURES

Once the transformer has been installed and all fixture locations determined, the next step is to run the correct size cable from the transformer to the fixtures while providing each fixture with between a 10.5 and 11.5 volt operating range. This is accomplished by:

- 1) Grouping fixtures into distance zones as illustrated below. Do not have a fixture that is 10' away from the transformer on the same cable run as one that is 100' away.
- 2) Use the proper cabling method for the application. Try to center load all cable runs when possible to minimize the voltage differential between fixtures. Maximum voltage differential between the first fixture and the last fixture on any given circuit should not exceed 1 volt with a 0.5 volt differential being optimum.
- 3) Use the correct size cable to accommodate voltage drop. As a general rule of thumb, limit the wattage load per each cable run to no more than 100 to 160 watts.
- 4) Choosing the correct voltage tap on the PX Transformer terminal block. The PX Series Transformer low voltage tap lugs are the biggest in the industry. If your system has 5 cable runs that all need to be installed into the 13 volt tap, multiple cables will easily fit into each of the lugs.

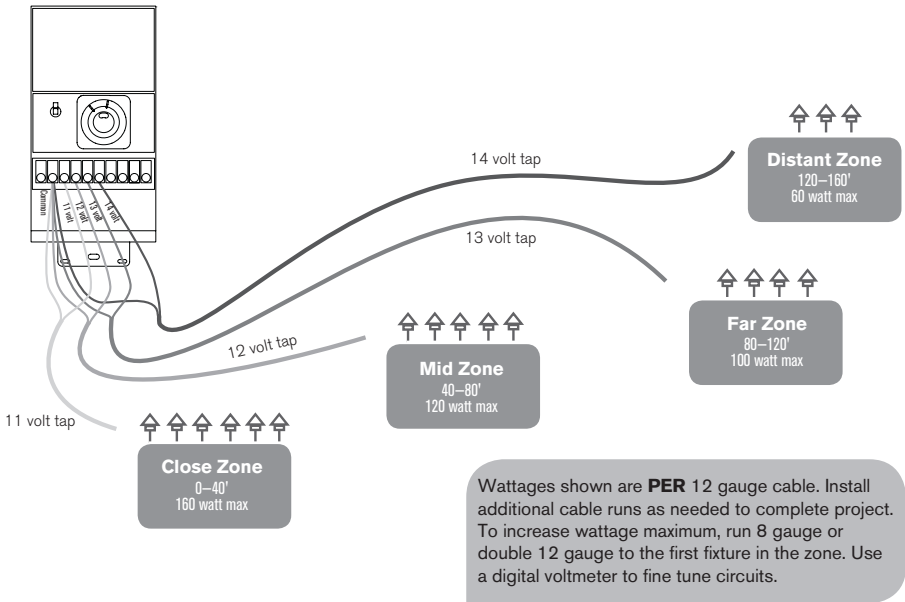

Summary: For maximum light output and lamp life, the goal when installing low voltage systems is to provide each lamp with between 10.5 and 11.5 volts. To stay within a 0.5 to 1.0 volt differential between the first light and the last light on a given circuit, you must group the fixtures into distance zones and not overload the cable with excessive wattage. As a rule of thumb, limit the distance between the first fixture and the last fixture on any given run to no more than 50 feet.

The FX MultiTap Transformer allows you the opportunity to utilize the voltage tap that will provide each circuit with the proper voltage. For cable runs in the "distant zone" you would typically select the 13 or 14 volt tap. For cable runs in the "close zone," you would typically install the cable run into the 11 or 12 volt tap depending upon the wattage load and size of cable.

CIRCUITING GUIDELINES

CABLE STATS

Low voltage lighting systems are typically installed using UF (underground feeder) rated stranded cable. The most common cable used is referred to as 12/2 stranded cable. The size of cable used in wiring the lighting system will be determined by the wattage load and the length of cable run from the transformer to the lighting fixtures.

It is very important to note that all low voltage cable has a maximum safe rating (see chart at right). Overloading cable can create a dangerous safety hazard so be sure to cable your lighting system with the proper size cable.

Wire Size	Max Load at 12 Volts
16/2	10.4 amps – 125 watts
14/2	12 amps – 144 watts
12/2	16 amps – 192 watts
10/2	24 amps – 288 watts
8/2	25 amps – 300 watts**

*** 8 gauge cable has the capacity of handling up to 32 amps and 384 watts of load; however, the maximum capacity of the circuit breaker in the transformer equals 25 amps or 300 watts!*

Low Voltage Cable: Each low voltage lighting cable consists of two parts. One part of the cable is designated to carry the voltage load and is referred to as the “hot” lead. The “hot” section is installed into one of the low volt “hot” lugs on the terminal block. The other section is referred to as the “common” lead and is installed into the lugs labeled “common.” Voltage is carried out from the transformer to the fixtures via the “hot” side of the cable and returns back to the transformer “common” tap via the other half of the cable thus completing the circuit.

Loads PER CABLE

Add cable runs as necessary



Close Zone 0–40' 12 Gauge 160 watts max. 10 Gauge 180 watts max. 8 Gauge 220 watts max.

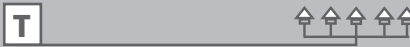

Mid Zone 40–80' 12 Gauge 120 watts max. 10 Gauge 140 watts max. 8 Gauge 200 watts max.

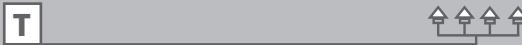

Far Zone 80–120' 12 Gauge 100 watts max. 10 Gauge 120 watts max. 8 Gauge 180 watts max.

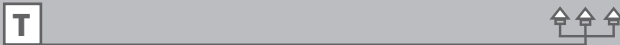

Distant Zone 120–160' 12 Gauge 60 watts max. 10 Gauge 100 watts max. 8 Gauge 160 watts max.

CABLING METHODS

Within each cabling zone, you may utilize any of a number of cabling methods. The primary objective is to minimize voltage drop by installing the proper size feeder cable (home run) to each zone and to make sure that each fixture on each cable run is receiving between 10.5 and 11.5 volts. Center feeding the “home run” (the main cable run from the transformer to the first fixture on the circuit) will help minimize the voltage differential between the first fixture and the last fixture on the cable run.

Daisy chain method – Daisy chained circuits are the least efficient cabling method as more voltage is fed to the first fixture on the run and due to voltage drop, each subsequent fixture receives less and less voltage. This cabling method is NOT recommended unless the voltage differential between the first and last fixture on the circuit is less than one volt.



Tee method – The tee method center feeds the “home run” section of the cable and reduces the voltage differential between the first fixture and the last fixture on either side of the “tee.” This method is the preferred circuiting technique as it is easy to install and minimizes the voltage drop between first and last fixtures.

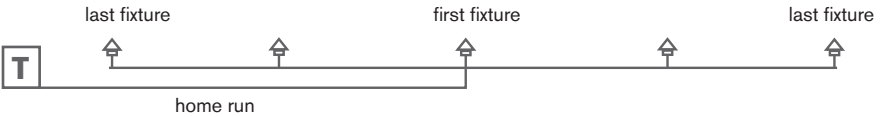

CONNECTING CABLES AT THE TERMINAL BLOCK

PX Series Transformer terminal block – The PX Series Transformer terminal block consists of 9 or 10 terminal lugs depending upon the transformer model. The PX 300 Series Transformer includes one “common” lug, an 11, 12, 13, and 14 volt “hot” lug and four lugs wired to the line voltage side of the transformer. The PX 600 Series Transformer terminal block has two “common” lugs, four low voltage “hot” lugs and four line voltage lugs. The PX 900 Series Transformer terminal block has three “common” lugs, a 12, 13, and 14 volt “hot” lug and the four line voltage lugs.

Each of the “common” lugs in any of the PX Series Transformers has a **maximum wattage capacity of 300 watts or 25 amps**. Each of the “hot” lugs in any of the PX Series Transformers has a maximum wattage capacity equal to the maximum load of the transformer. In other words, the 13 volt tap on a PX 600 Transformer can handle up to 600 watts of load. But the commons can handle only up to 300 watts each.

Terminal block of a PX 600 Series Transformer

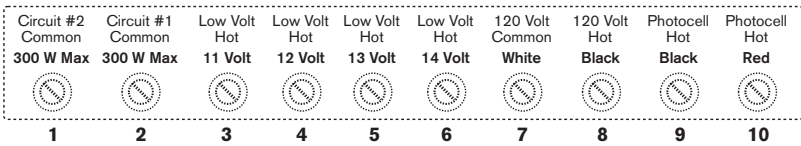

Number of cables in each lug – The PX Series Transformer has the industry’s largest terminal block lugs. You will be able to easily fit many cables into each voltage lug should your installation call for it. (We have actually installed over ten 12 gauge cables into a single lug.)

Common lugs – One conductor from each cable run coming from the lights to the transformer must be connected to one of the common lugs. As previously stated, each common lug can handle a maximum capacity of 300 watts or 25 amps of load. The other conductor will be installed into the hot lug that provides the optimum voltage for each circuit.

Choosing the proper “hot” voltage lug – Choosing the proper “hot” voltage lug in which to install the conductor is determined by the circuit’s voltage drop. If a circuit’s voltage drop is calculated to be about 3 volts, install the “hot” side of the cable into the 14 volt tap to assure proper voltage at the lamp. (14 volts minus 3 volts = 11 volts) Note: The voltage reading at each “hot” lug will vary depending upon the incoming voltage provided by the 120 volt receptacle. If the receptacle reads 128 volts, it is not uncommon for the 12 volt lug on the transformer to read 12.6–12.9 volts. On the other hand, if the receptacle is reading only 116 volts, the 12 volt lug may only read 11.8–12.2 volts. Always verify both high voltage and low voltage readings with a digital voltmeter. (See page 11) Fine tune each circuit by using a digital voltmeter. Lamps perform best when supplied between 10.5 and 11.5 volts. Before waterproofing wire connections, take a voltage reading at the first and last fixture on each circuit. If the voltage reading at the first fixture on the circuit reads less than 10.5 volts, move the conductor up to a lug that will provide approximately 11 to 11.5 volts. (Example – voltmeter reads 9.6 volts at the first fixture on the circuit and the conductor is was installed on the 11 volt lug. Move the conductor to the 12 or 13 volt lug and it will now read 10.6 or 11.6 volts.) If the voltage reading exceeds 12 volts, move the conductor down to a voltage tap that will meet the desired voltage range (10.5–11.5 volts).

Circuit breakers – All PX Series Transformers are protected with high quality circuit breakers located on the face of the transformer. The PX 300 has a single 25 amp circuit breaker. The PX 600 has two 25 amp circuit breakers and the PX 900 has three 25 amp circuit breakers. These circuit breakers should always remain in the “On” position; otherwise the system will not operate. They are NOT to be used as “On/Off” switches. Switching the transformer should be performed by other means. The circuit breakers are safety switches which will trip if the system experiences a short in the cabling or a system overload. If the circuit breakers are tripping, refer to the troubleshooting section of this guide. Once the problem has been resolved, the circuit breakers can be manually reset.

Internal circuit breaker – As an additional safety measure, each PX Series Transformer has an internal thermal overload circuit breaker that automatically shuts the system down should it be subjected to excessive heat. The internal circuit breaker cannot be manually reset. Once the transformer cools off (approximately 40 minutes), the internal breaker will reset and the system will reengage.

SWITCHING OPTIONS

TIMER INSTALLATION AND PROGRAMMING

Two "On/Off" timer settings can be programmed. This is useful for owners who want their lighting system to go off at 11 PM then come back on again in the early morning. To program two "On/Off" settings, place the first green "On" pin at 5 PM (or desired on time). Place the first red "Off" pin at 11 PM (or desired off time). Place the second green "On" pin at 4 AM and the second red "Off" pin at 6 AM. Note: Timer pins represent 30 minute intervals. It is very difficult to perfectly sync multiple transformers with separate timers. If synchronization is desired, contact FX Technical Services at 1-800-733-2823 for assistance.

The timer switching option provides an automatic method of turning your lighting system on and off at preselected intervals. The pictured timer is currently reading 8 PM and is scheduled to operate starting at 5 PM and shut down at 11 PM. To change the time of day, manually turn the dial clockwise until the desired time of day is reached.

The **Manual On/Off Switch** is located at the top left corner of the timer. To manually turn the timer on, turn the switch in a counterclockwise manner. To manually switch the timer off, rotate the switch one additional revolution counterclockwise.

For automatic timer control, set the **green pin** at the time of day the transformer is to be activated. (5 PM pictured)

Set the **red pin** at the time of day the transformer is to be shut off. (11 PM pictured)

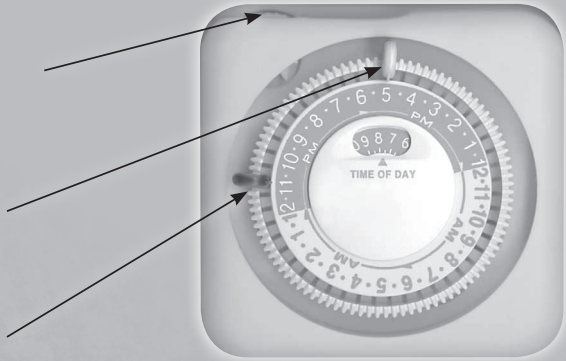

SWITCHING OPTIONS

PHOTOCELL INSTALLATION

The photocell switching option is a light sensitive device that allows your FX lighting system to become active at dusk and then shuts the system down when the sun comes up thus providing “dusk to dawn” performance. **VERY IMPORTANT:** The photocell is installed on the HIGH VOLTAGE side of the transformer! Be sure to unplug the transformer when installing the photocell.

Installing the photocell – With the transformer unplugged, remove the two screws on the face of the clear plastic terminal block panel. Lift the plastic panel up and out of the way. **Important:** Remove the red jumper wire located between the #9 and #10 lugs on the terminal block. The photocell comes equipped with three wires – a white “common” wire, the black “hot” wire, and a red switch wire. The white wire is installed into the lug labeled “120 volt common white”. The black wire is installed into the lug labeled “photocell hot black”. The red wire is installed into the lug labeled “photocell hot red”. Loosen each lug with a flathead screwdriver, install the photocell wires into the proper location and retighten lugs. Lower and reinstall clear plastic terminal block panel. Pop up the ½”, knockout on the right side of the transformer, push photocell photo eye out through the knockout and secure photocell to transformer using the rubber washer and plastic threaded nut.

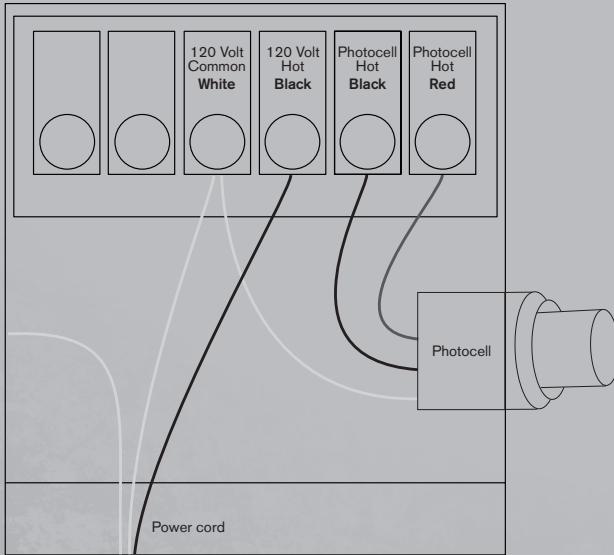

Timer plus photocell switching option – A popular method of switching your FX lighting system is to install both a timer and a photocell in the transformer. By setting the green pin at 4:00 PM and the red pin at 11:00 PM, your system will automatically turn on at dusk and shut down at 11:00 PM without having to change the timer setting with the changing of the seasons.

Testing timer and/or photocell during the daytime – To test the timer/photocell transformer during daylight hours, you will need to cover the photo eye on the photocell with either the bootie (included) or a piece of black electrical tape in order to simulate darkness.

If functioning properly, it will take up to 2 minutes for the photocell to activate. Do not prematurely assess that the photocell is defective. After waiting a couple of minutes, turn the timer's manual override switch on.

CABLE CONNECTORS AND SPLICING METHODS

Making good wire connections at each fixture and at the transformer terminal block is critical for the long-term success of the lighting project. Poor wire connections can cause more problems than any other aspect of the lighting system installation. If connections are not properly made and become loose or subject to exposure to moisture, the system will eventually experience problems ranging from corrosion buildup and voltage drop to wire nut meltdown leading to a potential fire hazard.



Step 1

Using wire strippers designed for stranded cable, cut the cable in half and strip back $\frac{3}{4}$ " of the insulation from each side to expose the copper wire.

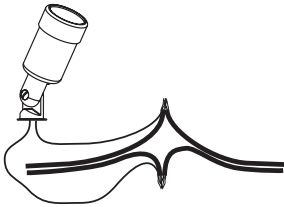

Step 2

Join each of the fixture's socket wires to each side of the cable as shown. Since there is no polarity in low voltage, it doesn't matter which side is which when joining the conductors together. Install a red wire nut to each wire twisting clockwise until secure. Now's the time to test the voltage at each fixture. (See page 11)

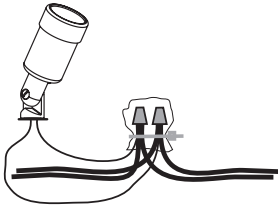

Step 3

Pump about two squeezes of splice gel into the LiteSplice baggie and insert both wire nuts into it. Push out the air and work the gel into the bottom portion of the wire nuts fully encapsulating the wire connection with splice gel. Install cable tie and cinch down to complete the waterproof connection.

Cable at Fixture Locations

For system flexibility and future fixture relocation, it is best to leave 18–24" of slack cable at each fixture location. Bury extra cable at base of fixture.

LAMP LIFE

- Lamp life is rated in hours of operation. If lamps are rated for 4000 hours at 12 volts, it means that at 4000 hours, 50% of the lamps are still working and 50% are not.
- For maximum light output, tune lighting circuits to provide between 11.5 and 12.0 volts as measured at lamp terminals when all of the lamps on the circuit are operating.
- For longer lamp life, adjust voltage down so lamps receive between 10.5 and 11.5 volts at the lamp terminals.
- Voltage can be regulated by adjusting circuit load/run by using FX PotenzaX Transformers.
- To determine circuit voltage, use digital voltmeter.

Volts at Lamp	Lamp Life of Rate	Lumen Output of Rated
13.0*	50%	350%
12.5*	75%	175%
12.0	100%	100%
11.5	200%	80%
11.0	300%	75%
10.5	500%	65%
10.0	900%	50%

* This voltage is not recommended

INSTALLATION TOOLS

Receptacle Tester – (Fig 8.1) This tool tells you whether or not the 120 volt receptacle you are plugging the PX Transformer into is wired properly. Two orange lights indicate proper wiring. The GFCI version allows you to test the GFCI for proper operation.

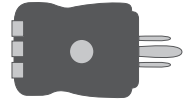
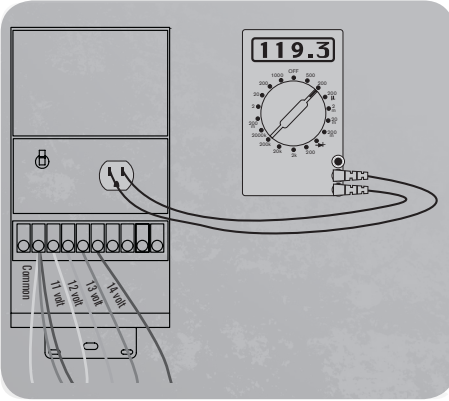
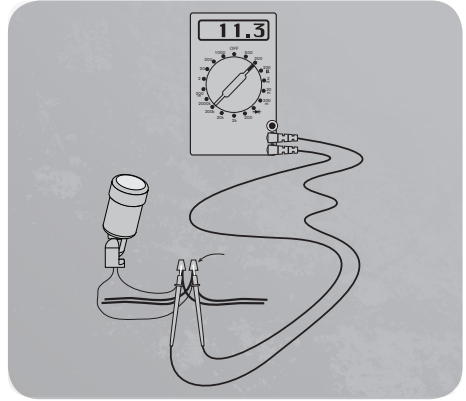

Fig 8.1

Digital Voltmeter – This tool allows you to take important voltage readings at the transformer, at each fixture and at the receptacle the transformer will be plugged into. Dial the digital voltmeter two clicks to the right on 200 ~ setting.



Checking voltage at transformer (Fig. 8.3)
Remove timer, insert voltmeter probes into receptacle (Safe voltage reading between 117 and 125 V)



Checking voltage at fixtures (Fig. 8.5)
Insert voltmeter probes into each wire connector (Optimum reading between 10.5 and 11.5 V)

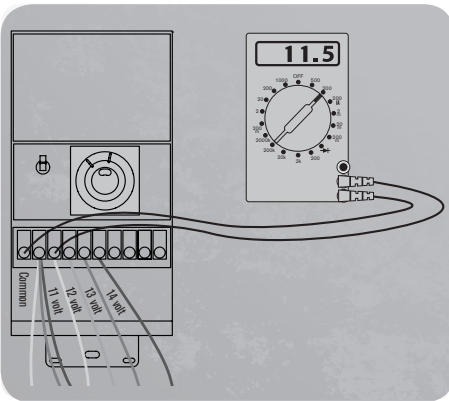

Checking voltage at Lugs (Fig. 8.4)
Manually switch on timer, cover photocell if applicable. (Each lug should read no more than +/- 0.3 to 0.9 volts of rated output)

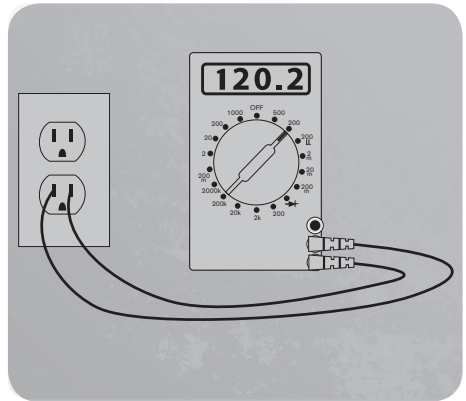

Checking voltage at plug (Fig. 8.2)
(Safe voltage reading between 117 and 125 V)

THE AMP CLAMP: Lighting Professional's Tool of Choice

The amp clamp is both a digital voltmeter and an amp probe combined. This tool can be used to check system voltage, amperage and continuity. It is a most valuable troubleshooting tool that can save you time and frustration.

To test amperage on the fluke amp clamp, set the dial to \bar{A} . To test voltage with a fluke amp clamp, set the dial to V~.

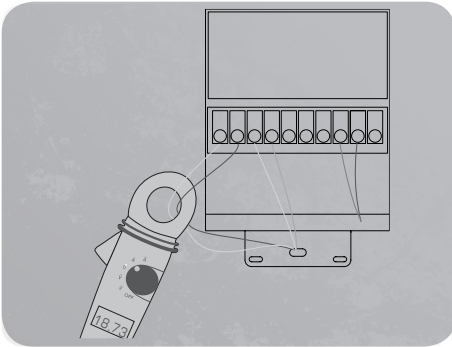

Checking Amperage at Transformer Commons (Fig. 9.1)

Set amp clamp to \bar{A} . Clamp all wires on each common. Maximum amp load per common is 25 amps. If amp reading exceeds 25 amps, there is either a short in the wiring or a wattage overload on one or more cables installed in the common being tested.

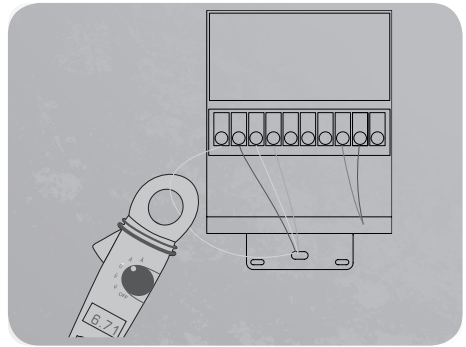

Testing Amperage on single cable (Fig 9.2)

Set amp clamp to \bar{A} . Clamp each wires on commons. Check cable specs to compare amp reading with safe loads.

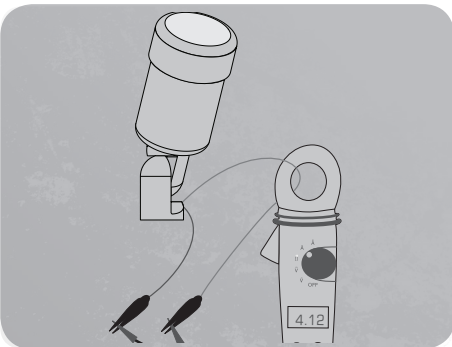

Testing Amperage at Fixtures (Fig. 9.3)

Set amp clamp to \bar{A} . Clamp only one wire lead. This reading will help you determine the wattage rating of the fixture's lamp.

- 0.8 reading (+/-) = 10 watt lamp
- 1.6 reading (+/-) = 20 watt lamp
- 2.9 reading (+/-) = 35 watt lamp
- 4.1 reading (+/-) = 50 watt lamp

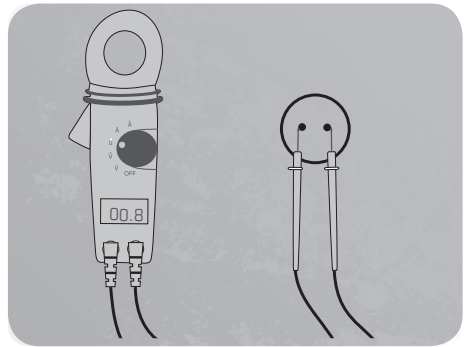

Testing Continuity (Fig 9.4)

Place amp clamp on the Ω setting. Put probes on each side of conductor or lamp pins. If clamp tones or attempts to reach 0.000, there is a continuous circuit. Lamp/cable is good. If clamp does not tone and stays at 1.0 setting, there is a break in the line or lamp is no good.

TROUBLESHOOTING THE LIGHTING SYSTEM

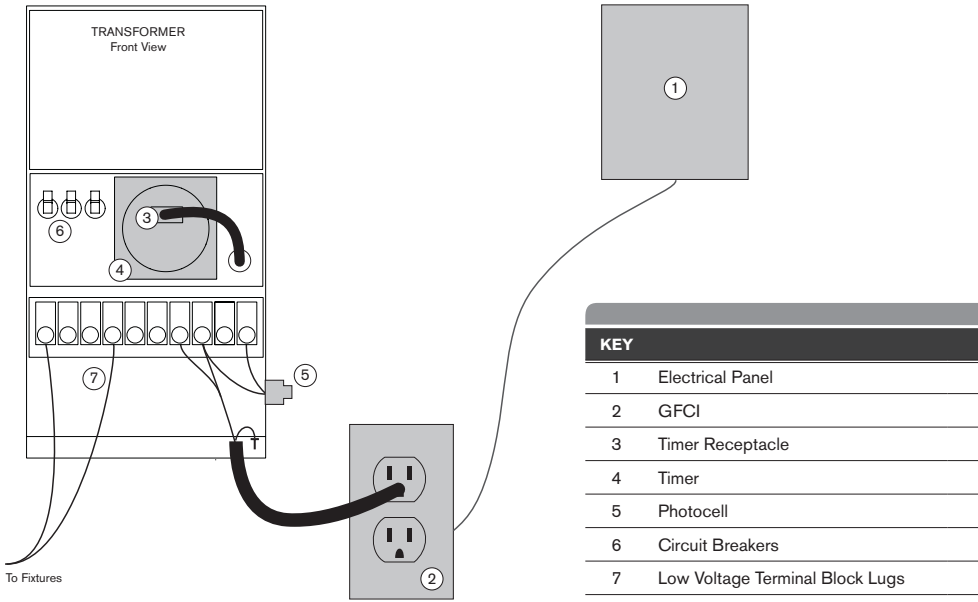

Testing the PX Power Path – With a digital voltmeter or amp clamp, check the voltage reading at the receptacle on the face of the transformer (3) by first removing the timer (4). If voltage reading is between 117 V–125 V, you know you have power from the electrical panel (1) to the transformer. If the volt reading at the transformer receptacle (3) is 0, the problem lies between the transformer and the electrical panel. Be sure the transformer is plugged into the GFCI receptacle (2). Check to see if the GFCI (2) has tripped. If so reset. Check to see if the circuit breaker in the electrical panel (1) has tripped. If so, reset. **Note:** Some exterior receptacles (2) are protected by GFCI circuit breakers that are located elsewhere in the residence. Check in kitchen, laundry room, bathrooms. Reset if tripped. Then recheck voltage at (3).

Testing the Timer (4) – If the system is equipped with a timer and you suspect it may be malfunctioning, remove Timer and test voltage at transformer receptacle. If reading is +/- 120 volts, you've got power to the transformer. Replace timer and test by manually turning the timer on (switch is on the upper left side of the timer). If the system does not come on, remove timer and plug pigtail directly into receptacle on face of transformer. If system now works, the timer is defective. Replace timer. **Note:** Factory-installed timers have a maximum load capacity of 1750 watts. If daisy chaining transformers together in a master-slave configuration that exceeds 1750 watts of load, install a timer with the capacity to handle the additional load.

Testing the PhotoCell (5) – If the system is equipped with a photocell, test by placing the bootie or a piece of black electrical tape over the photo eye. Wait approximately 2 minutes for the system to activate. When testing a transformer with both timer and photocell, be sure you have manually switched the timer to the “On” position. If the system does not activate after 2 minutes, unplug the transformer from power supply (2). Remove photocell. Reinstall the red jumper wire between the #9 and #10 lugs. Plug the transformer back into the power supply. If Transformer now works, you have isolated the problem to a bad photocell. Replace with new photocell. **Note:** FX factory-installed photocells have a maximum wattage capacity of 1000 watts. If daisy chaining transformers together in a master-slave configuration that exceeds 1000 watts, install a commercial grade photocell.

TROUBLESHOOTING THE LIGHTING SYSTEM (CONTINUED)

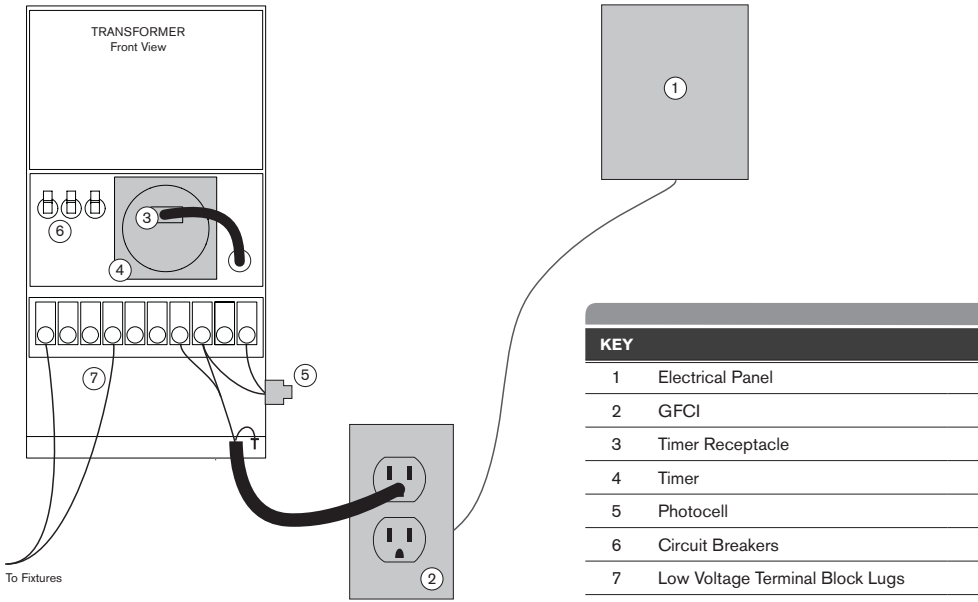

Circuit breakers (6) on transformer keep tripping – If the circuit breakers (6) on the face of the transformer keep tripping, the system is experiencing either a circuit overload or there is a short in the system.

Circuit overload – If the amperage load on any given common lug exceeds 25 amps, the circuit breaker will trip. Test the amperage load on all cables on each common lug using an amp clamp (see Fig 9.1). The digital amp clamp should be set on the 200 A setting. Test each individual cable on each common lug with the amp clamp. (See page 12) To remedy an overload, either reduce the wattage of the lamps in the fixtures or rebalance the amp load between commons. Remember, each common can handle a maximum of 25 amps.

Using the digital amp clamp, turn clamp on to the 200 A setting.

- Clamp around the cables on each common.
- Clamp each individual wire on each common.
- A reading over 25 amps on any given common indicates circuit overload. This is not a transformer problem; it's an installation issue.

Short Circuit – The circuit breakers (6) will trip if there is a short somewhere in the cabling. To test for a short circuit, check each cable on the common tap that is tripping individually. If one cable reads excessively high – 10+ amps higher than it should – there is most likely a short somewhere in that circuit. Example: A circuit with 100 watts of load (five 20 watt fixtures) should have an amp reading of approximately 8 amps. If the cable is reading 18 amps or more, it has a short somewhere in the cable.

Note: Shorts and overloads are NOT covered by the FX warranty and can only be detected when the transformer is tested in the field.

SYSTEM DIAGNOSIS AND TROUBLESHOOTING

ADDITIONAL SYSTEM DIAGNOSTICS

It is extremely difficult to troubleshoot an electrical system without the proper tools. The two most essential diagnostic tools used for electrical troubleshooting are the digital voltmeter and the amp clamp. The amp clamp has both voltage and amperage reading functions and is the tool of choice for the professional lighting installer.

Most problems with 12 volt systems stem from inadequate cable size, incorrect cabling methods and non-waterproof wire splices. Refer to our circuiting guidelines.

PROBLEM	CAUSE	SOLUTION
No power at plug	Tripped breaker or GFCI	Reset circuit breaker in main panel or the GFCI usually located in a bathroom, garage, or kitchen.
GFI keeps tripping	Ground problem or defective GFCI	GFCIs are notorious for nuisance tripping. Use a high grade model such as the Hubbell #GF5252L.
Transformer is cycling on and off at night	Excessive wattage load or short	Reduce lamp wattage, fixture quantity, or increase size of transformer. See shorting solution below.
Photocell transformer is cycling on & off in the daytime	Photocell wiring incorrect	Reverse the hot and common wires on the photocell 120 V input. Request wiring schematic for proper wiring.
One cable run not working	Cut cable or short	Test cable for voltage. If none, it is cut. If there is very low voltage and the cable is hot, there is a short. Check all fixtures and splices for defects.
Lamps are burning out prematurely	Excessive voltage at lamp	Drop the affected cable run down to the next lower voltage tap or increase wattage load on that cable to drop voltage. Also, some lamps are rated for a very short life such as the 4414 (300 hours). Use halogen lamps.
The closest lamp to the transformer is burning out prematurely	Excessive voltage at lamp	The closest lamp will always have a higher voltage reading than the last lamp. Cable fixtures so that there is about 40' from first to last within a lighting zone. See system layout for details.
Lamps have a yellow or golden tone	Voltage too low	Move affected cable to the next higher voltage tap or reduce load on cable. If possible, run additional cable to first fixture to reduce voltage loss.
Lamp goes on and off when fixture is moved	Too much tension on socket leads	With spring type sockets, it is important to leave some slack so the socket contacts make a good connection to the lamp base.
System is getting dimmer with age	Splices are corroding	As non-waterproof splices corrode, they create electrical resistance which reduces voltage. To fix, simply dig up all splices on the project and waterproof them with FX LiteSplice or equal. Do not use black electricians tape.
Photocell transformer is coming on too soon	Transformer is in dark location	In order to operate properly, the photocell must have a good look at daylight. Move to a brighter location.
Fixtures have a white mineral deposit on them	Irrigation water is hitting them	Schedule the irrigation to come on after the lights have gone off. This is especially true with the 50 W spots – very hot.

GLOSSARY

WORD	DEFINITION
Amp	Unit of measure of electrical flow through wire or other conduit; the volume of current; the number of electrons flowing past a given point per second; analogous to GPM
Circuit	The path of electrical current from power source through cable to fixtures and back to the source
Circuit Breakers	A safety device that opens (shuts down the flow of electricity) a circuit when a short or overload occurs. Line voltage circuit breakers found in the house electrical panel used on circuits for low voltage lighting systems are typically rated for either 15 or 20 amps. Low voltage circuit breakers found in UL 1838 compliant transformers have a load capacity of 25 amps.
Continuity	An uninterrupted electrical path
Load	Total amperage or wattage on a circuit
Overload	Current demand exceeding that which the cable or circuit breaker was designed
Run	Distance of cable from the transformer to fixtures
Short Circuit	Improper connection between hot wires or between a hot wire and a neutral wire
Voltage	A measure of electrical force or pressure; that which causes electrical current to flow through cable; analogous to PSI
Voltage Drop	The loss of electrical pressure
Watts	A unit of measure of electrical power or consumption

SYSTEM MAINTENANCE

Periodic system maintenance is required to keep your FX lighting system operating at peak performance. Practicing these maintenance suggestions will lengthen the life and enjoyment of your garden lighting design.

Transformer maintenance – Perform the following annually

- Tighten all terminal lugs on transformer
- Blow out all bugs and webs
- Check timer, photocell, or other switching options

Lighting fixtures and lamps

Important: When replacing lamps, be sure to replace with lamps of same wattage and beam spread.

- Check all fixtures and replace burned out lamps quarterly
- Clean dirty lenses with Lime Away® and treat with Rain-X® to minimize calcium deposits annually
- Check aiming angles of fixtures semi annually
- Straighten all pathway lights quarterly
- Trim all plant material as needed; relocate fixtures as needed as plant materials mature
- Clean debris off well light lenses and grates quarterly

Cable and cable connectors

- Rebury cable and connectors that may have crept to the surface
- Check, adjust, and replace as needed all cable and cable ties in trees

WARRANTY

FX LUMINAIRE TRANSFORMER WARRANTY POLICY AND PROCEDURE

FX Luminaire warrants its transformers from manufacturer's defects for a period of 10 years from the date of installation. If an FX Transformer should fail due to manufacturing defects within this period, FX Luminaire will repair or replace the faulty unit free of charge.

If you suspect that your FX Transformer has failed due to a manufacturer's defect, contact FX Technical Services at 1-800-733-2823 for assistance and warranty procedure. Do not remove the transformer until you have contacted Technical Services. Many problems can be solved over the telephone without having to remove the transformer from the premises.

To properly assist you with your warranty inquiry, Technical Services will want to know the following information:

- The model number of the transformer
- Transformer switching options (timer, photocell, timer, and photocell, etc)
- Date of installation
- Who installed the transformer (if known)
- A description of the nature of the problem
- Has there been any recent change to the lighting system? For instance, were new lamps recently installed? Were additional fixtures added to the system? Have there been lightning storms or heavy rains?

What's excluded from the FX Transformer warranty:

- Insignificant defects such as scratches, minor mechanical or electrical maladjustments, or any manufacturing error that can be easily corrected
- Improper installation methods that cause or contribute to the failure of an FX product
- Lamps (bulbs) are not warranted

For additional technical support, please visit www.fx.com and refer to the Learning Center link or call our Technical Services Department at 1-800-733-2823.

QUESTIONS?

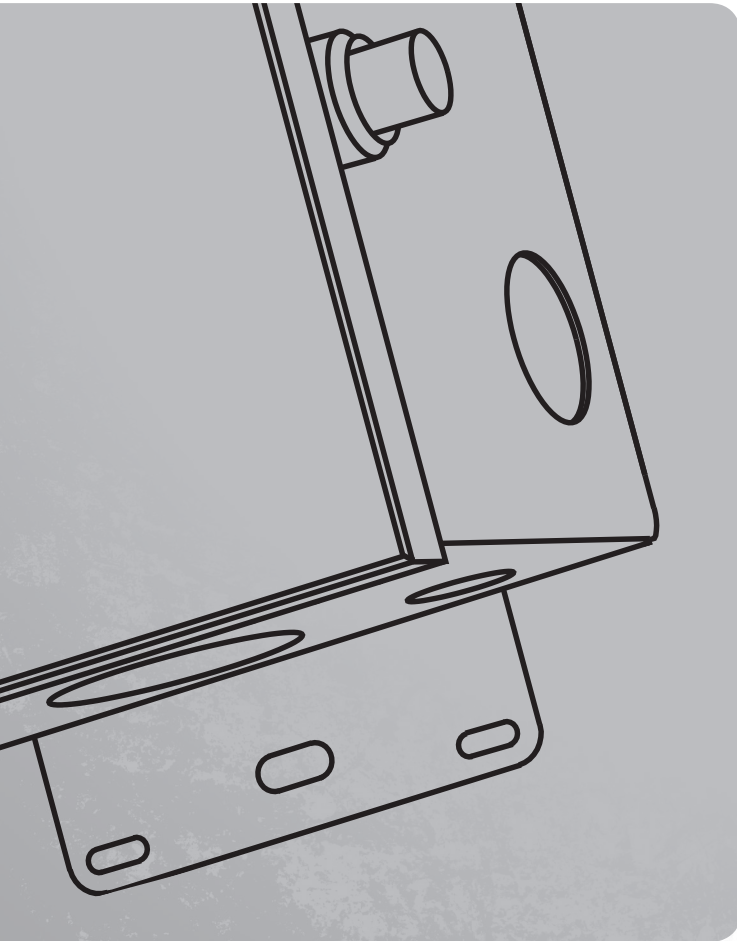

TechLine
1-800-733-2823

Website
www.fxl.com